



Print on thick paper
>300 g/m²
Imprimer sur papier épais
>300 g/m²



Fold the grooves before
gluing
Plier les rainures avant
collage

Rafale M

installation instructions

Making the Rafale M papercraft
is simple!

First print the model, then cut, fold and
glue it to have your Rafale M ! Average
time required : 8 hours

Scale 1:40

notice de montage

Réaliser votre Rafale M est simple !
Imprimez le modèle puis découpez et
assemblez les pièces pour obtenir
votre Rafale M !

Temps moyen de montage : 8 heures

échelle 1:40

step étape 1

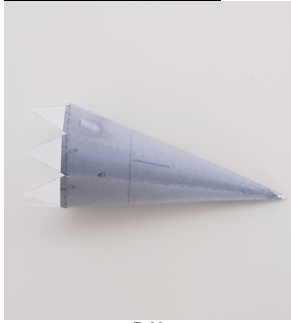

P 09

step étape 2



Remove à découper

P 08

step étape 3

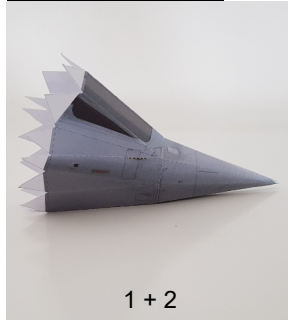

1 + 2

step étape 4



P 11

step étape 5



step étape 6

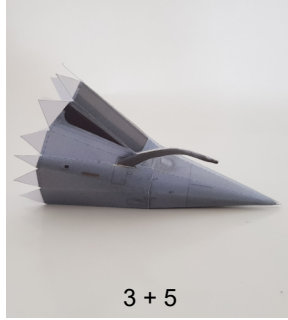

3 + 5

step étape 7

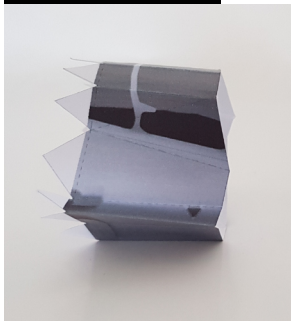

P 03

step étape 8

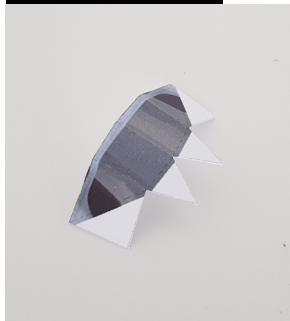

P 05

step étape 9

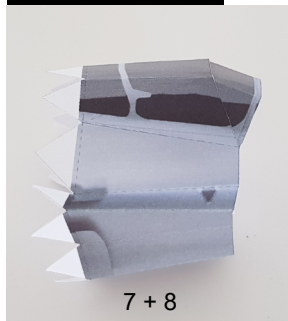

7 + 8

step étape 10



6 + 9

step étape 11



P 04

step étape 12

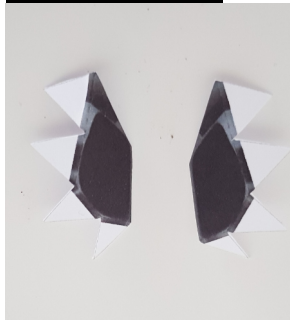

P 06, P 07

step étape 13

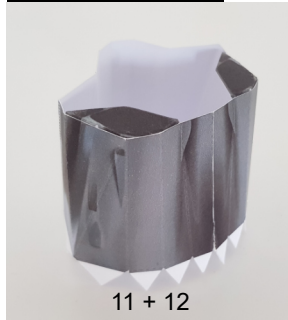

11 + 12

step étape 14

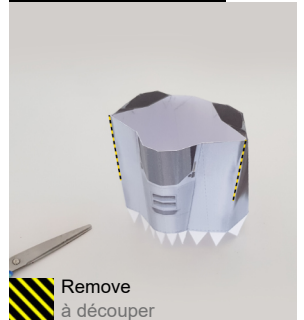

Remove à découper

step étape 15

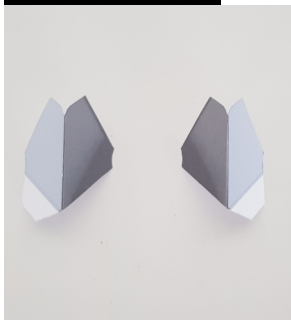

P 01, P 02

step étape 16

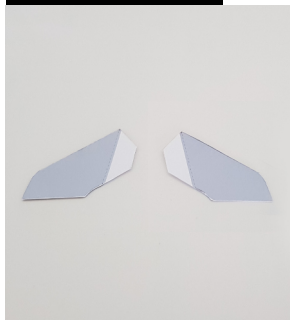

step étape 17



14 + 16

step étape 18



10 + 17

step étape 19

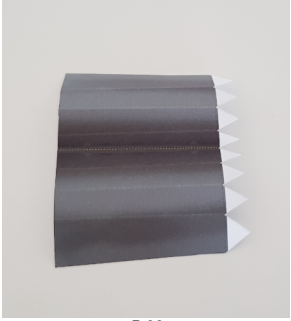

P 23

step étape 20



18 + 19

step étape 21

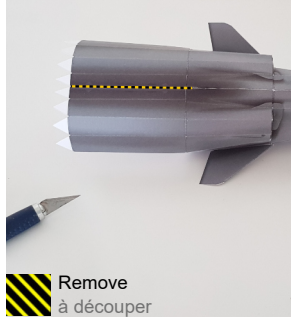

Remove à découper

step étape 22

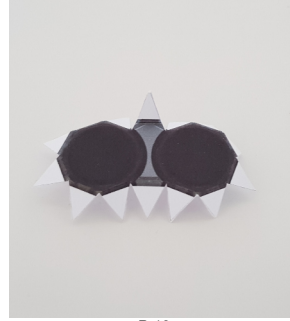

P 12

step étape 23

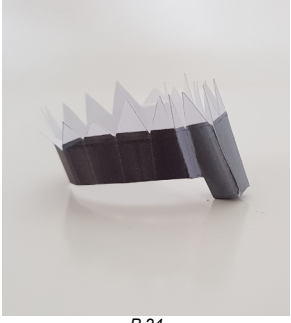

P 24

step étape 24



22 + 23

step étape 25



P 21

step étape 26

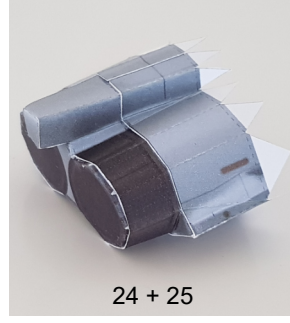

24 + 25

step étape 27

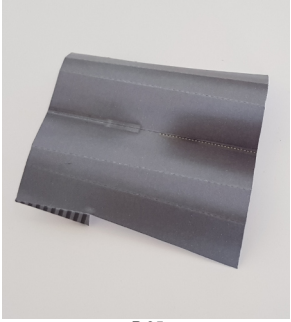

P 25

step étape 28



26 + 27

step étape 29

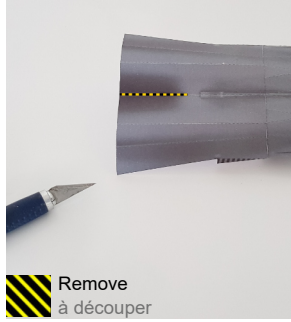

Remove à découper

step étape 30



21 + 29

step étape 31

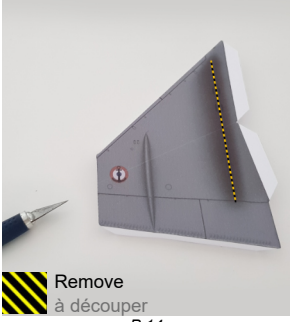

Remove à découper P 14

step étape 32



Remove à découper P 18

step étape 33



30 + 31

step étape 34



32 + 33

step étape 35



P 19 , P 20

step étape 36



step étape 37

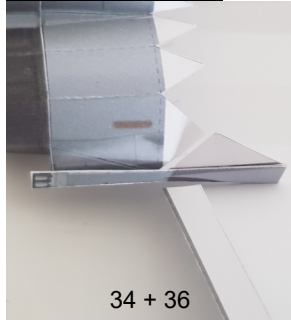

34 + 36

step étape 38

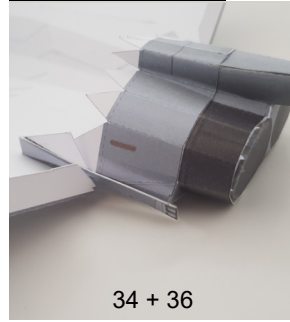

34 + 36

step étape 39

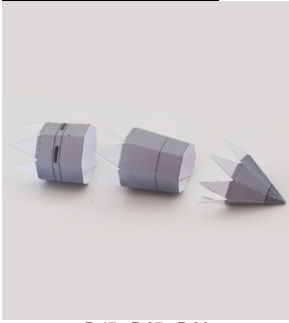

P 17, P 27, P 26

step étape 40



step étape 41

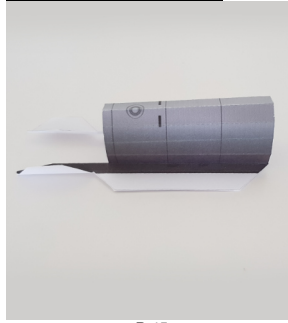

P 45

step étape 42

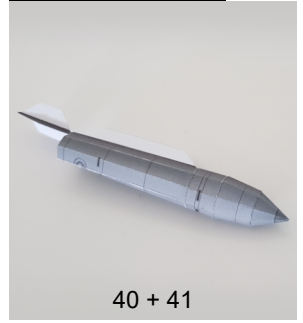

40 + 41

step étape 43



P 30

step étape 44

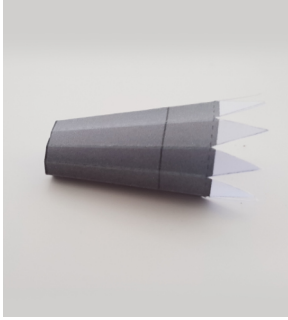

P 29

step étape 45

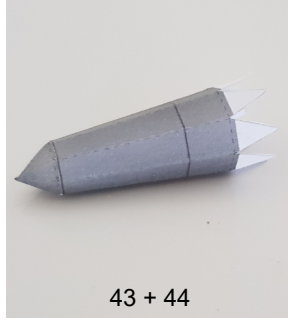

43 + 44

step étape 46

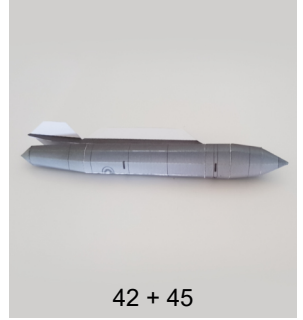

42 + 45

step étape 47



38 + 46

step étape 48



P 10

step étape 49

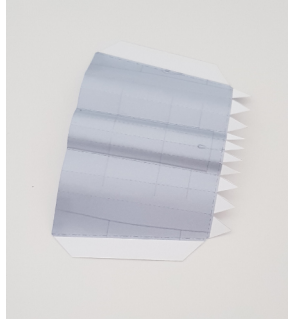

P 22

step étape 50



48 + 49

step étape 51



47 + 50

step étape 52



P 13

step étape 53



51 + 52

step étape 54

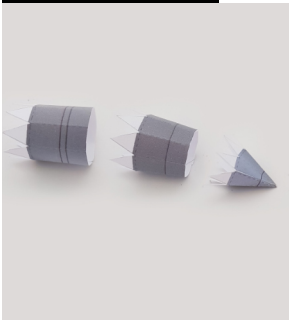

P 33, P 32, P 31

step étape 55

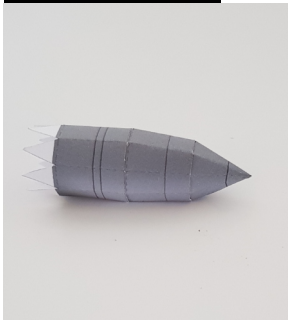

step étape 56



P 34

step étape 57

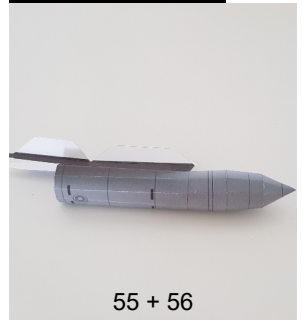

55 + 56

step étape 58



P 35

step étape 59

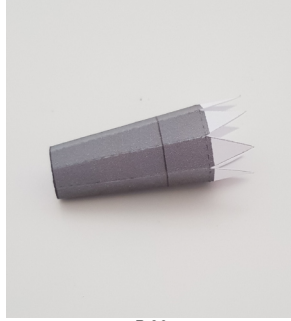

P 36

step étape 60



58 + 59

step étape 61

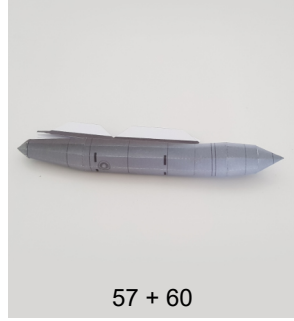

57 + 60

step étape 62



53 + 61

step étape 63

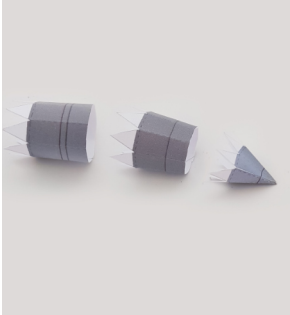

P 40, P 39, P 37

step étape 64

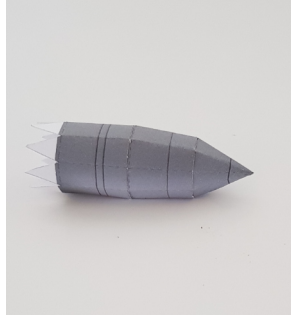

step étape 65

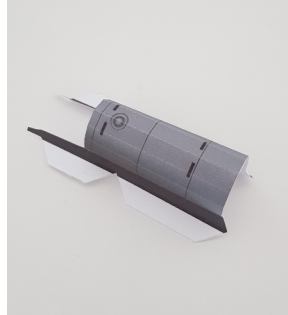

P 38

step étape 66

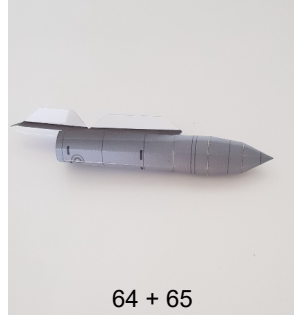

64 + 65

step étape 67



P 42

step étape 68

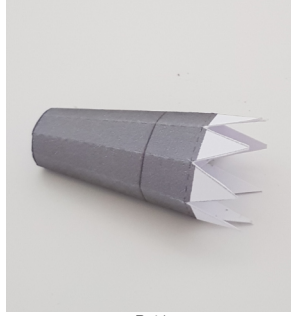

P 41

step étape 69

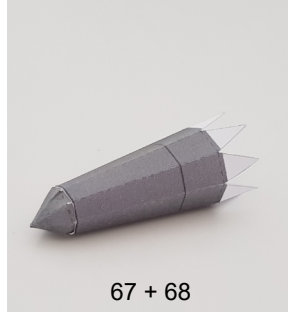

67 + 68

step étape 70

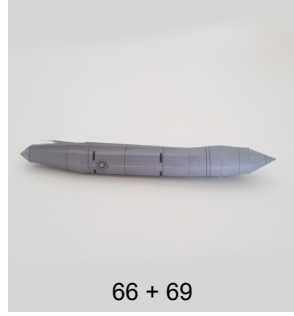

66 + 69

step étape 71



62 + 70

step étape 72

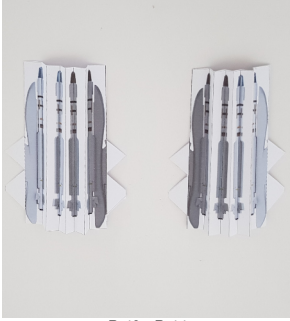

P 43, P 44

step étape 73

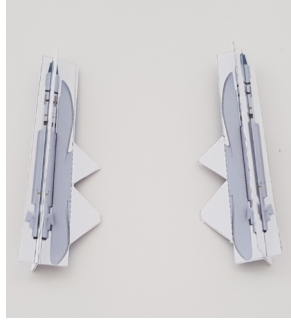

step étape 74

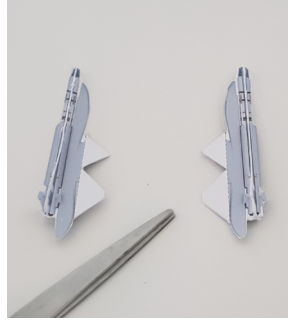

step étape 75

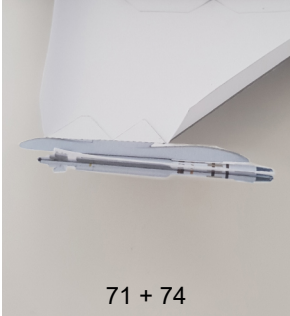

71 + 74

step étape 76

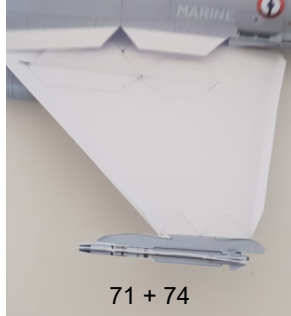

71 + 74

step étape 77



P 15, P 16

step étape 78



76 + 77

step étape 79



P 28

step étape 80



P 46

step étape 81

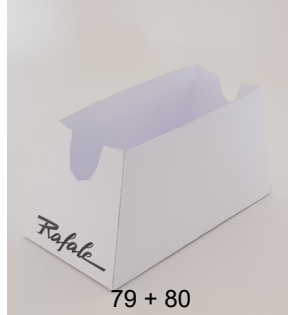

79 + 80

step étape Final



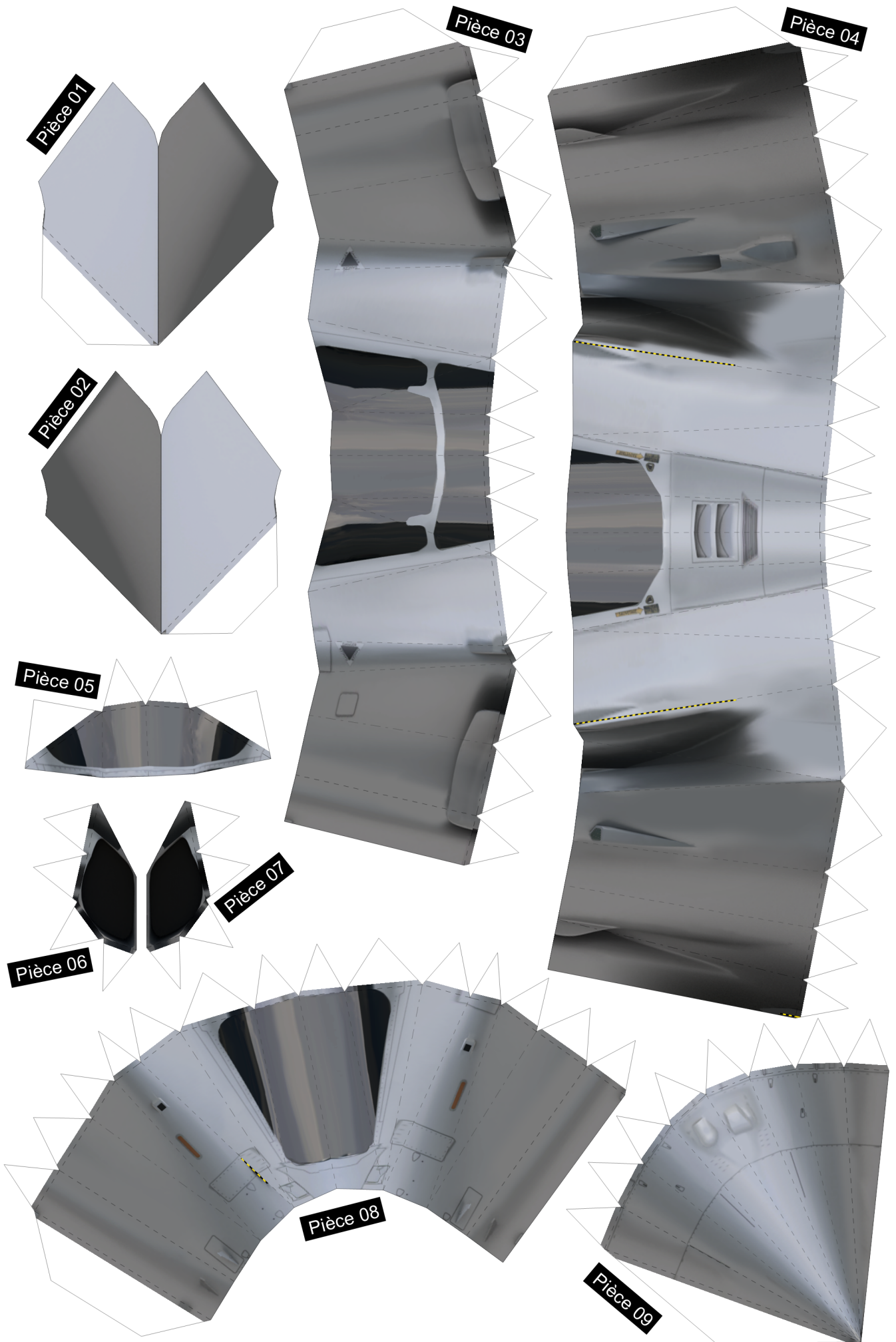



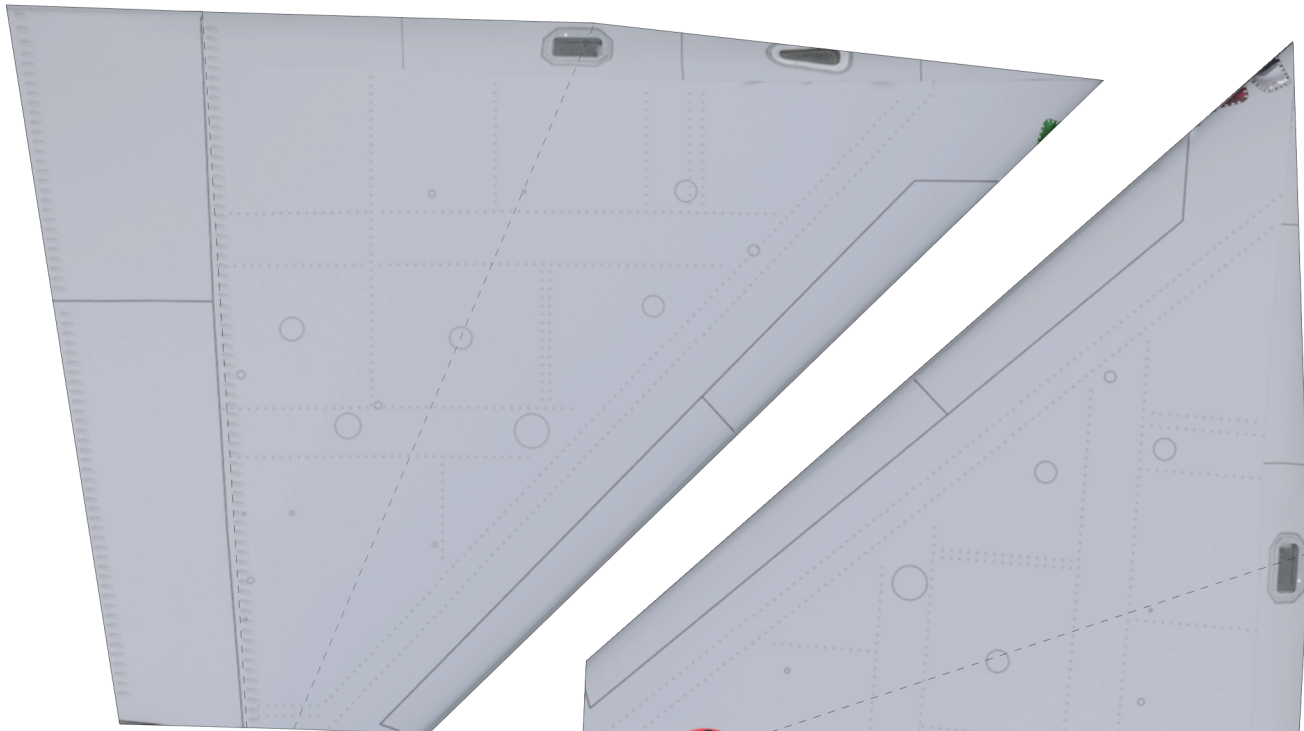

Pièce 15

Pièce 16

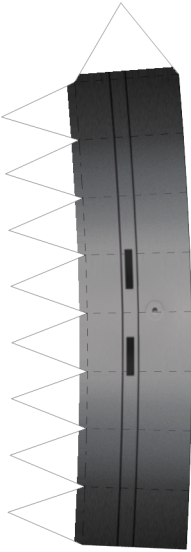

Pièce 17

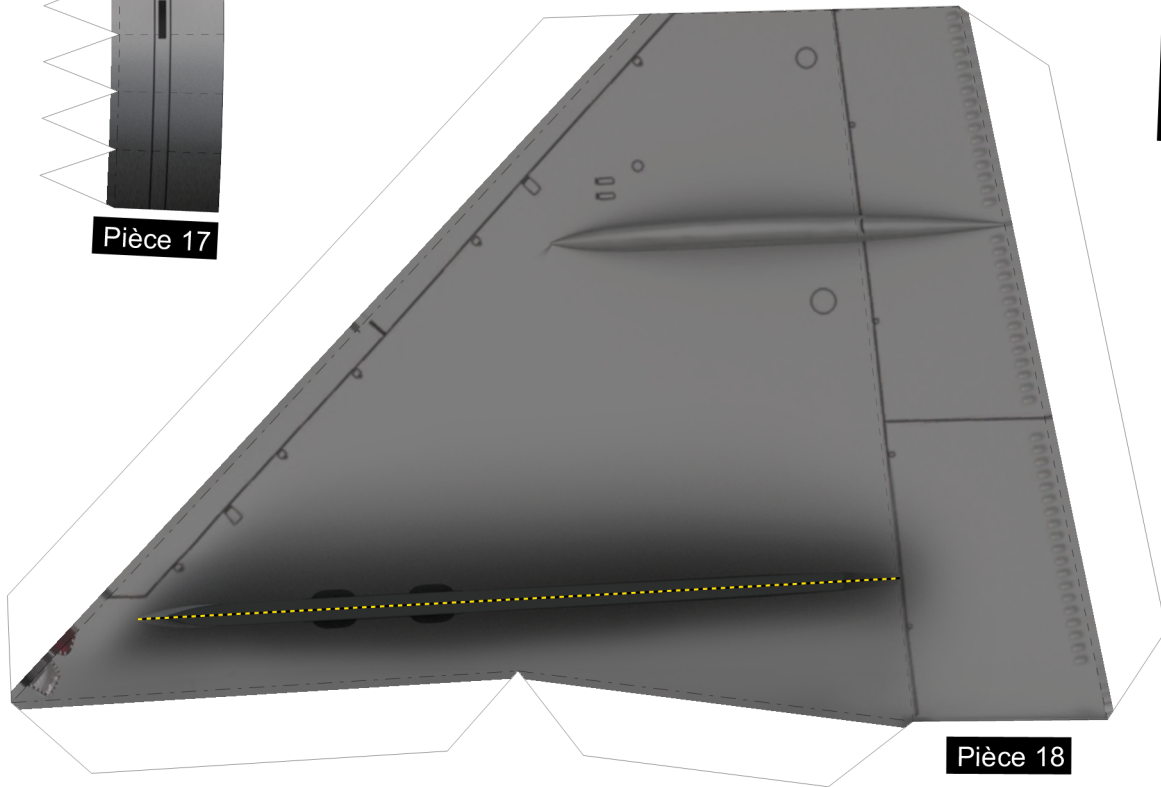

Pièce 18

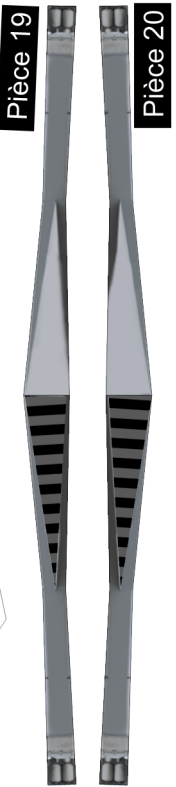

Pièce 19

Pièce 20

Pièce 22

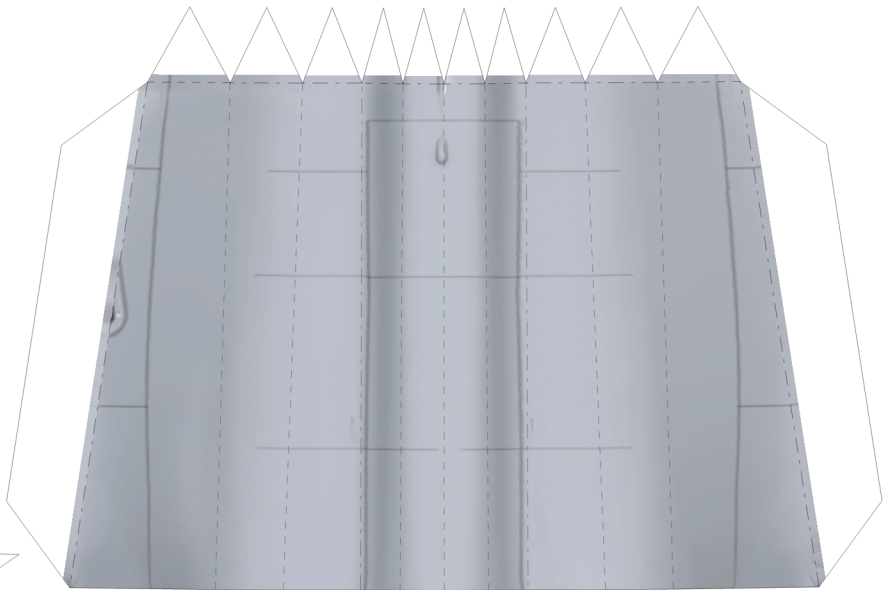

Pièce 21

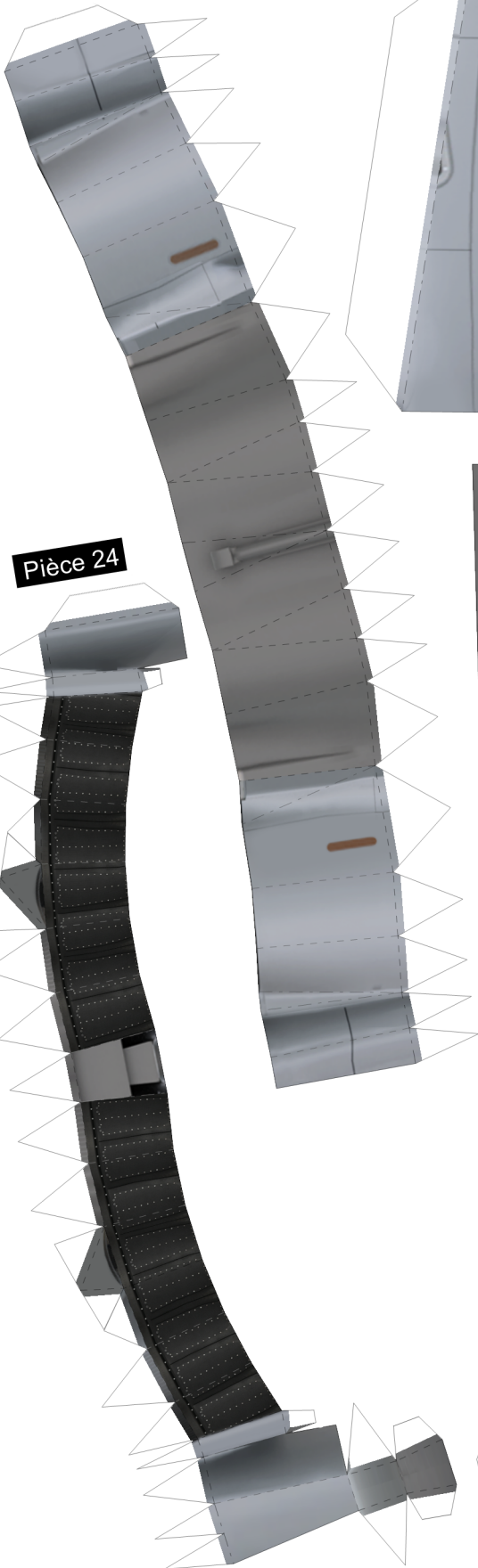

Pièce 24

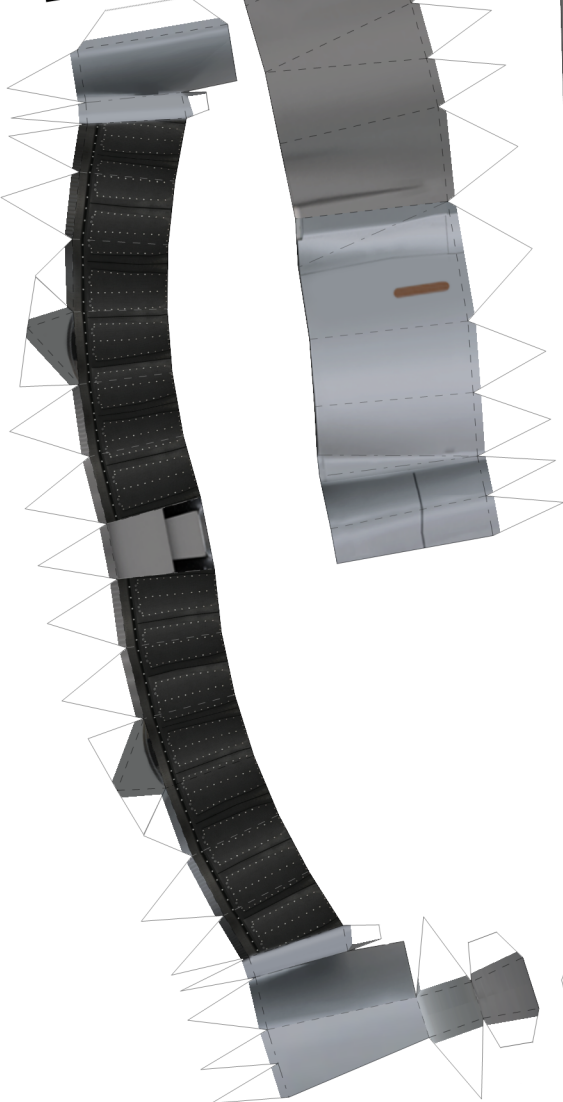

Pièce 23

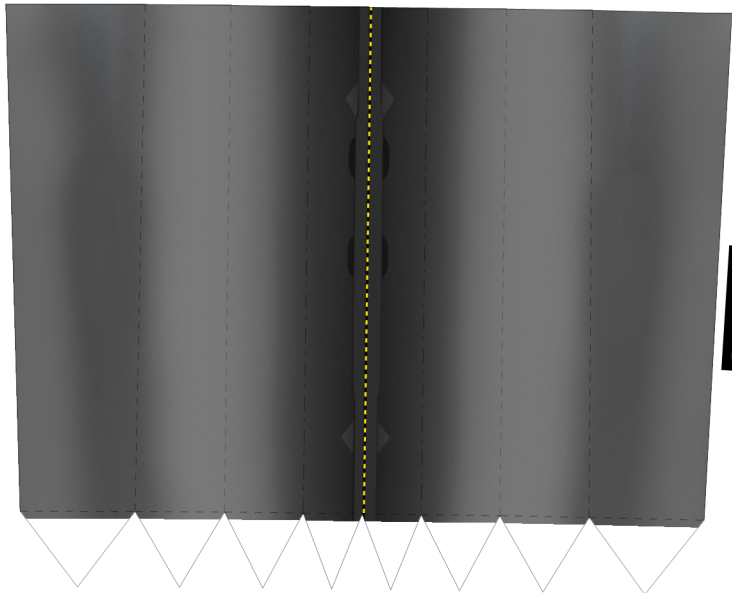

Pièce 25

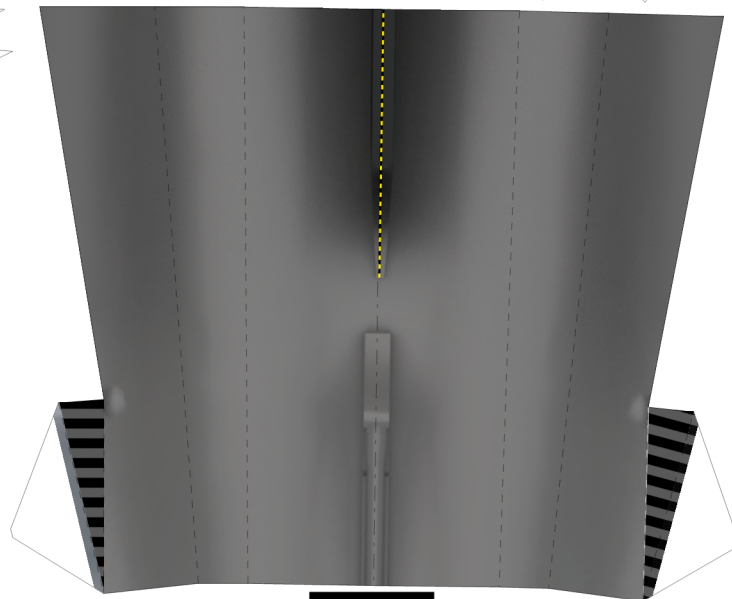

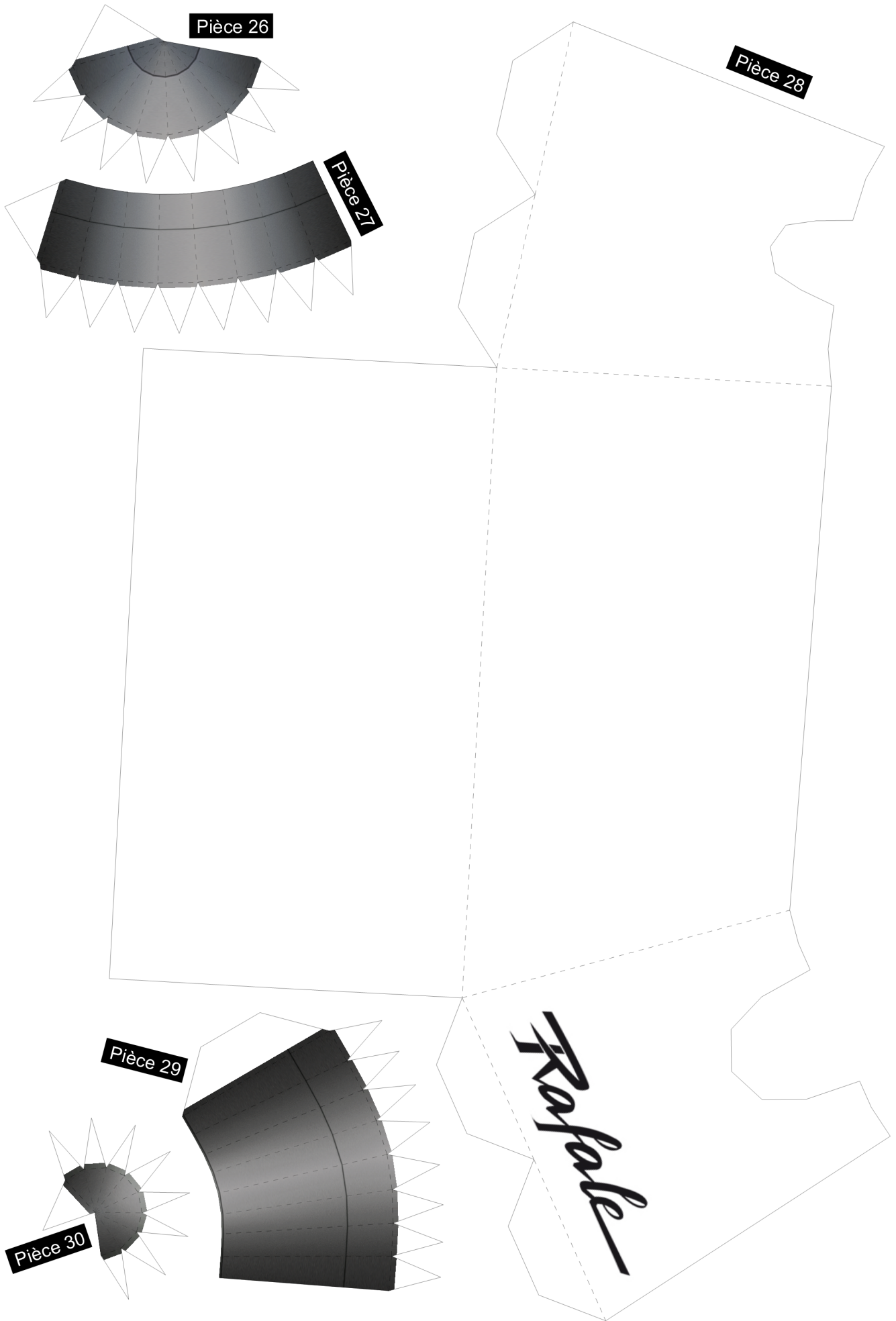



Pièce 43



Pièce 44



Pièce 45



Pièce 46

